

REVISIONS			
REV.	DESCRIPTION	DATE	APPROVED
A	ADDED NEW HOUSING & GASKET DESIGN	5/24/06	DH

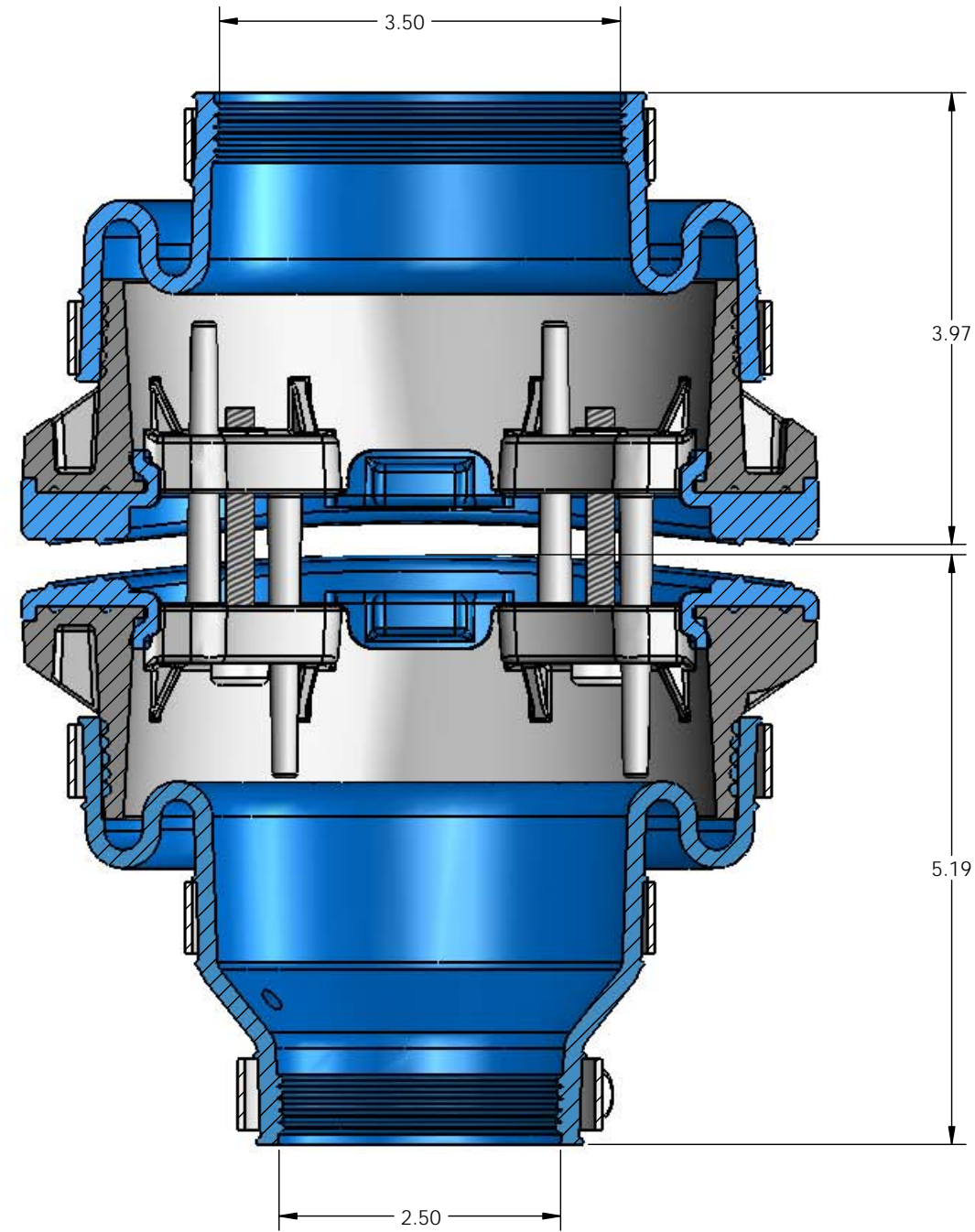
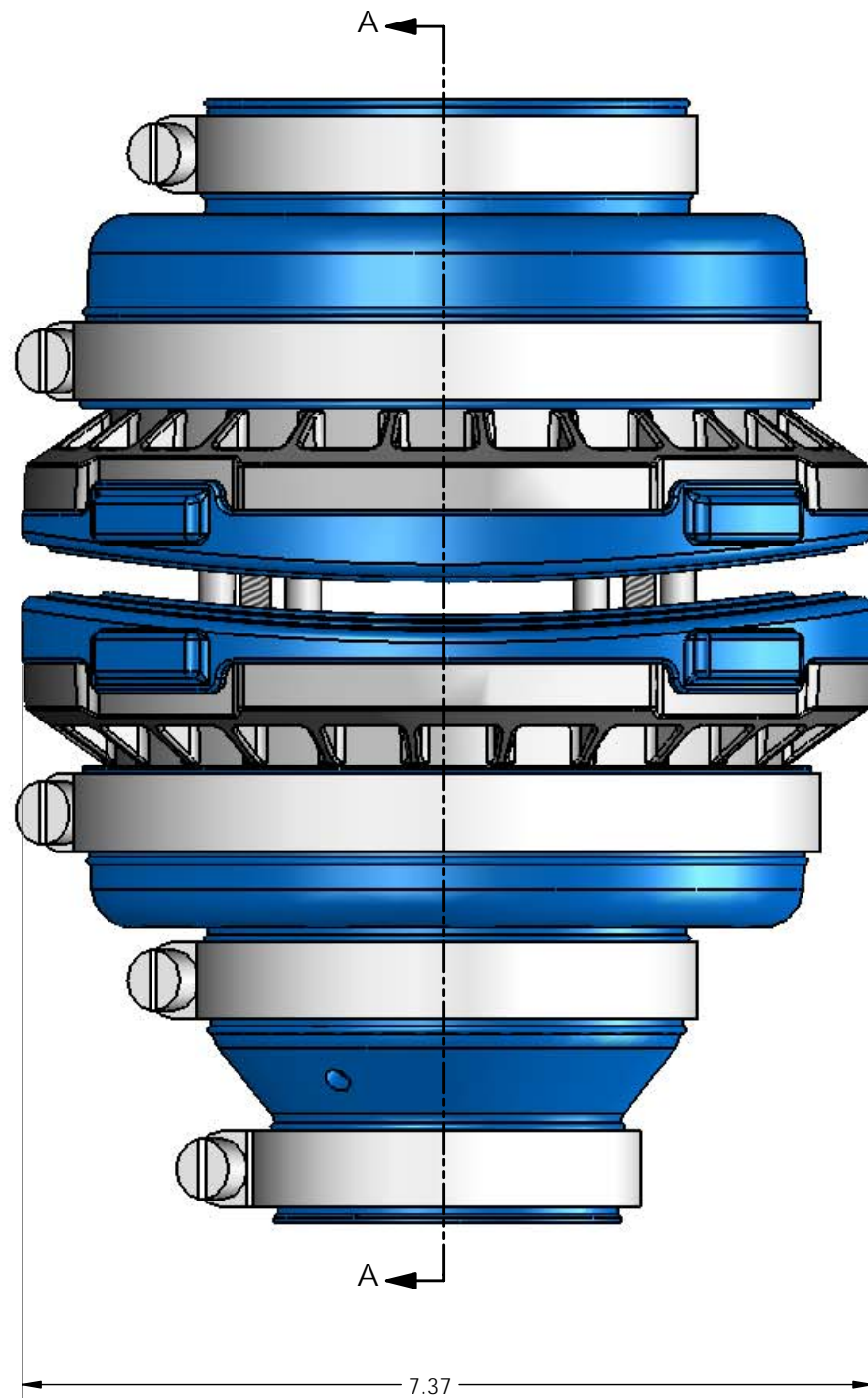

SECTION A-A

PROPRIETARY AND CONFIDENTIAL
 THE INFORMATION CONTAINED IN THIS DRAWING IS THE SOLE PROPERTY OF BLUELINE TECHNOLOGIES LLC. ANY REPRODUCTION IN PART OR AS A WHOLE WITHOUT THE WRITTEN PERMISSION OF BLUELINE TECHNOLOGIES LLC IS PROHIBITED.

UNLESS OTHERWISE SPECIFIED:		NAME	DATE
DIMENSIONS ARE IN INCHES		DRAWN	DH 12/1/04
TOLERANCES:		CHECKED	
FRACTIONAL ±		ENG APPR.	
ANGULAR: MACH ± BEND ±		MFG APPR.	
TWO PLACE DECIMAL ±		Q.A.	
THREE PLACE DECIMAL ±		COMMENTS:	
MATERIAL			
FINISH			
DO NOT SCALE DRAWING			



TITLE:		
KFDC 3.5x2.5A		
SIZE	DWG. NO.	REV
C	3.5x2.5A Cross Section	A
SCALE: 1:1	WEIGHT:	SHEET 1 OF 1