

REVISIONS			
REV.	DESCRIPTION	DATE	APPROVED

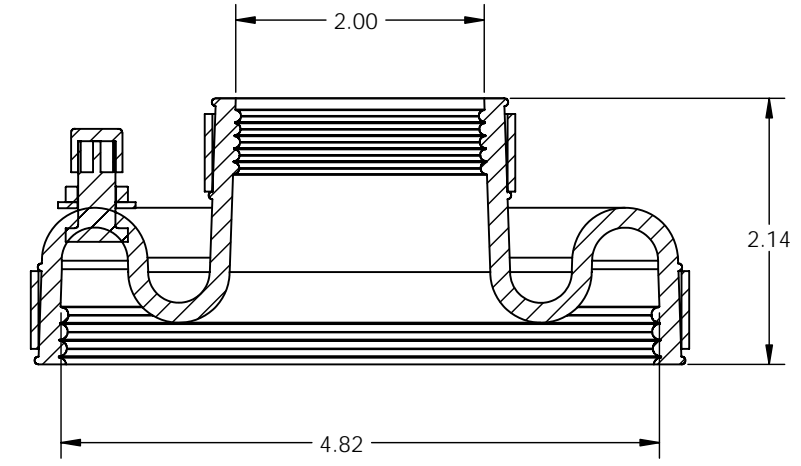
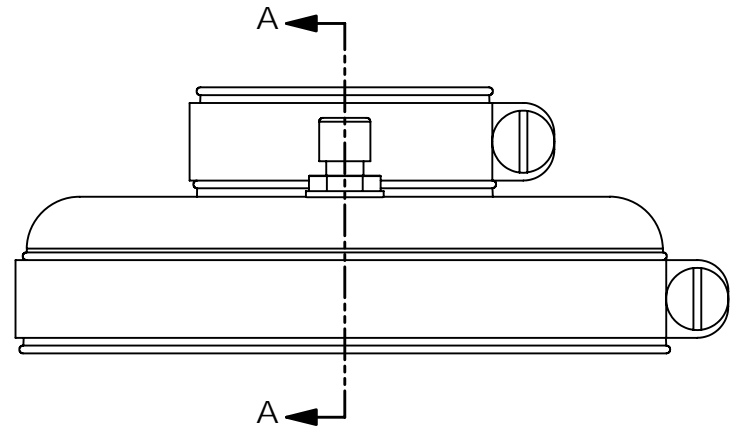
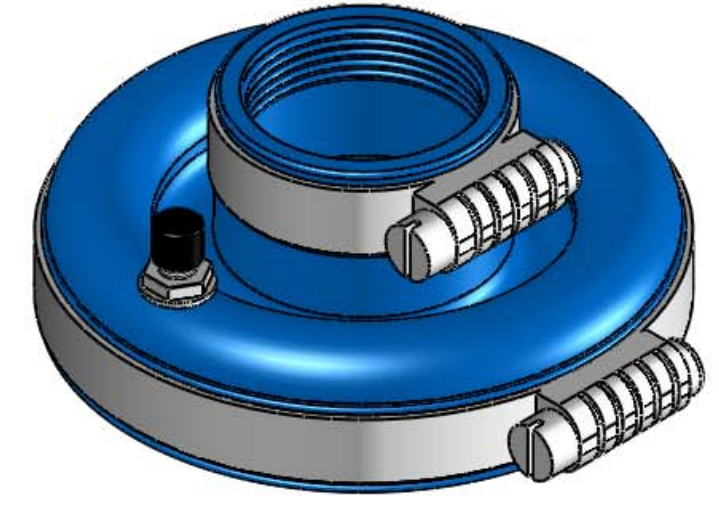
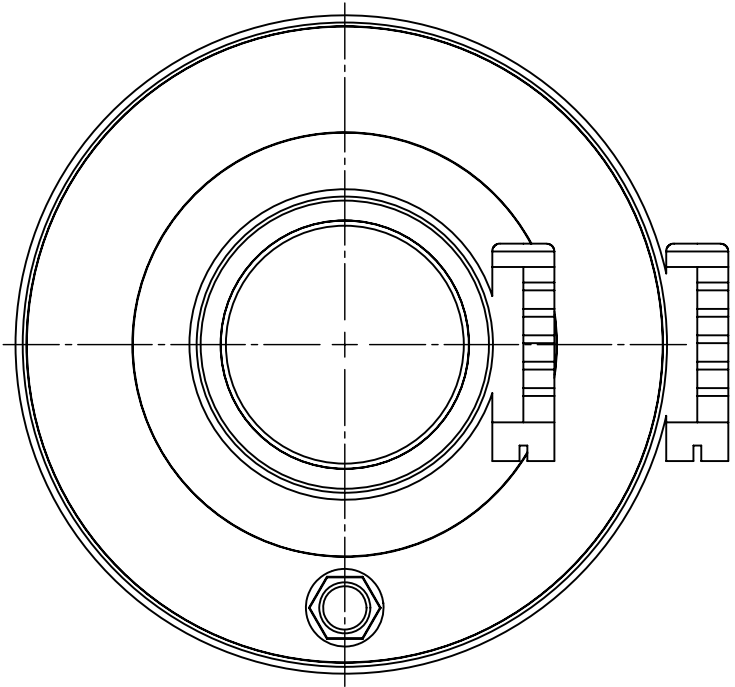

SECTION A-A

PROPRIETARY AND CONFIDENTIAL
 THE INFORMATION CONTAINED IN THIS DRAWING IS THE SOLE PROPERTY OF **BLUELINE TECHNOLOGIES LLC**. ANY REPRODUCTION IN PART OR AS A WHOLE WITHOUT THE WRITTEN PERMISSION OF **BLUELINE TECHNOLOGIES LLC** IS PROHIBITED.

UNLESS OTHERWISE SPECIFIED:	NAME	DATE
DIMENSIONS ARE IN INCHES	DRAWN	DH 12/1/04
TOLERANCES:	CHECKED	
FRACTIONAL ±	ENG APPR.	
ANGULAR: MACH ± BEND ±	MFG APPR.	
TWO PLACE DECIMAL ±	Q.A.	
THREE PLACE DECIMAL ±	COMMENTS:	
MATERIAL		
FINISH		
DO NOT SCALE DRAWING		



TITLE:		
PER 4.8x2.0A		
SIZE	DWG. NO.	REV
C	PER 4.8x2.0A	
SCALE: 1:1	WEIGHT:	SHEET 1 OF 1