

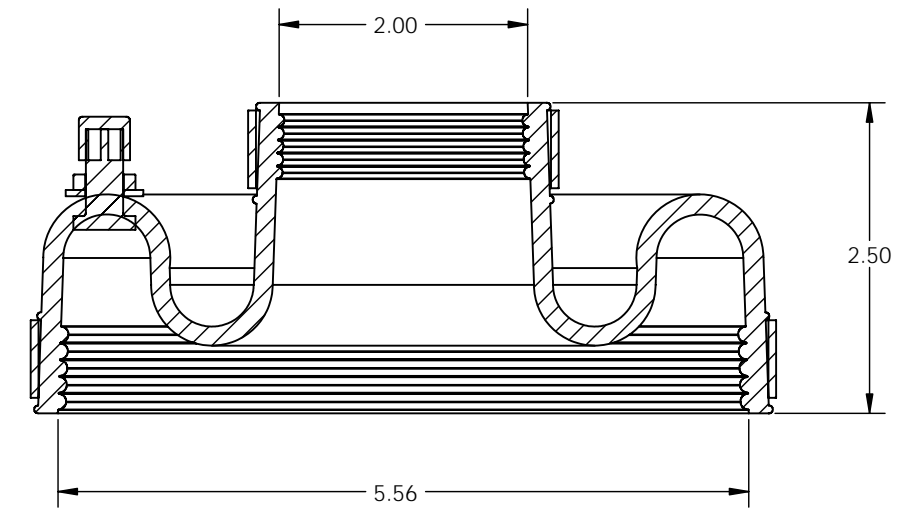

REVISIONS			
REV.	DESCRIPTION	DATE	APPROVED

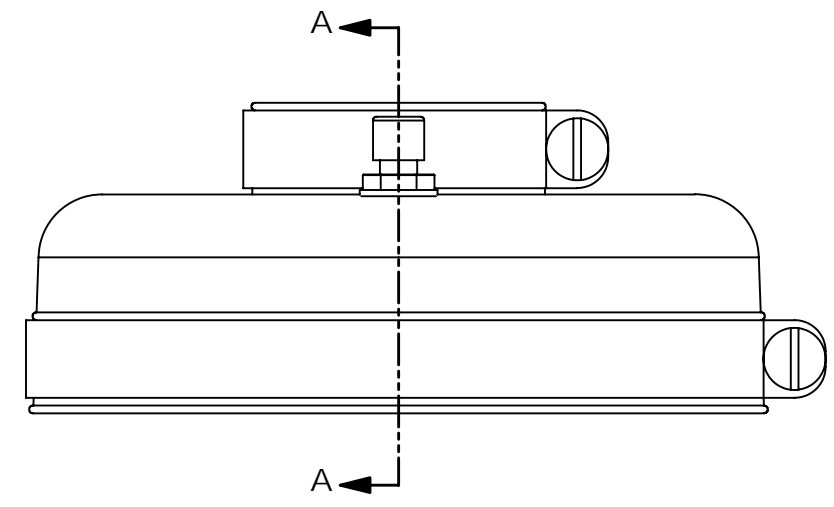
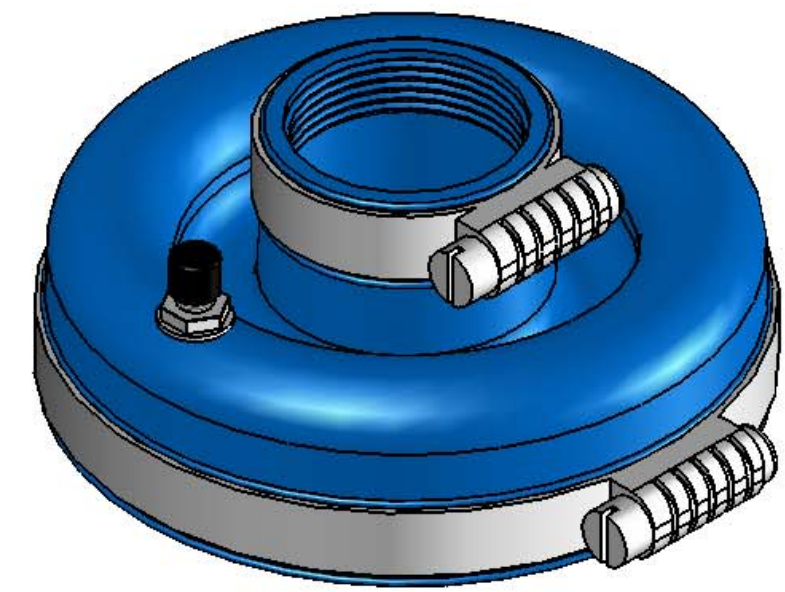
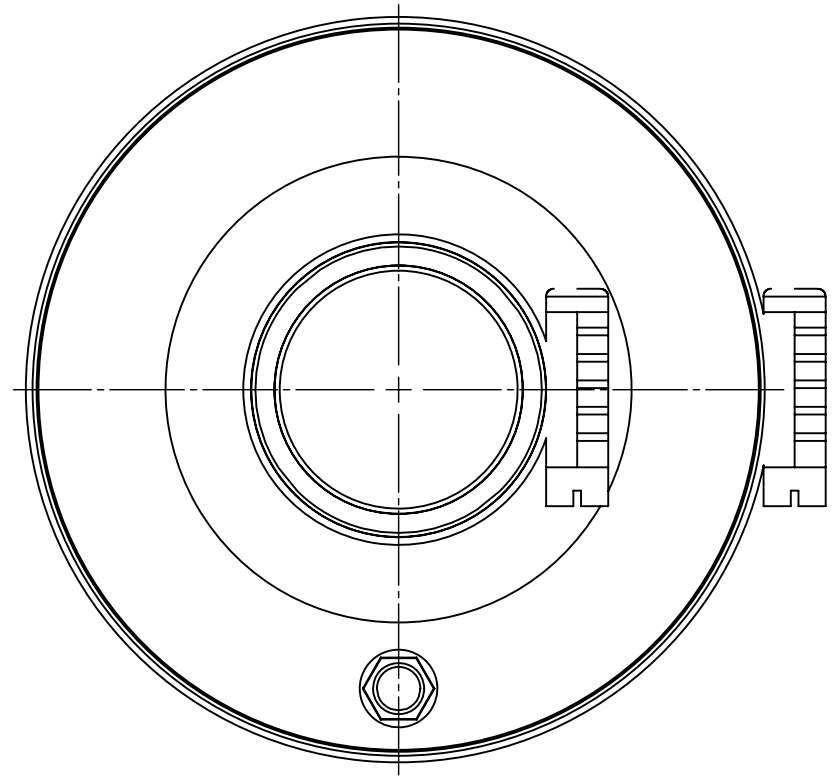

SECTION A-A

PROPRIETARY AND CONFIDENTIAL
 THE INFORMATION CONTAINED IN THIS DRAWING IS THE SOLE PROPERTY OF **BLUELINE TECHNOLOGIES LLC**. ANY REPRODUCTION IN PART OR AS A WHOLE WITHOUT THE WRITTEN PERMISSION OF **BLUELINE TECHNOLOGIES LLC** IS PROHIBITED.

UNLESS OTHERWISE SPECIFIED:	NAME	DATE
DIMENSIONS ARE IN INCHES	DRAWN	DH 6/23/04
TOLERANCES:	CHECKED	
FRACTIONAL ±	ENG APPR.	
ANGULAR: MACH ± BEND ±	MFG APPR.	
TWO PLACE DECIMAL ±	Q.A.	
THREE PLACE DECIMAL ±	COMMENTS:	
MATERIAL		
FINISH		
DO NOT SCALE DRAWING		



BlueLine Technologies, LLC

TITLE: **PER 5.5x2.0A**

SIZE	DWG. NO.	REV
C	PER 5.5x2.0A	

SCALE: 1:1 WEIGHT: SHEET 1 OF 1