

REVISIONS			
REV.	DESCRIPTION	DATE	APPROVED

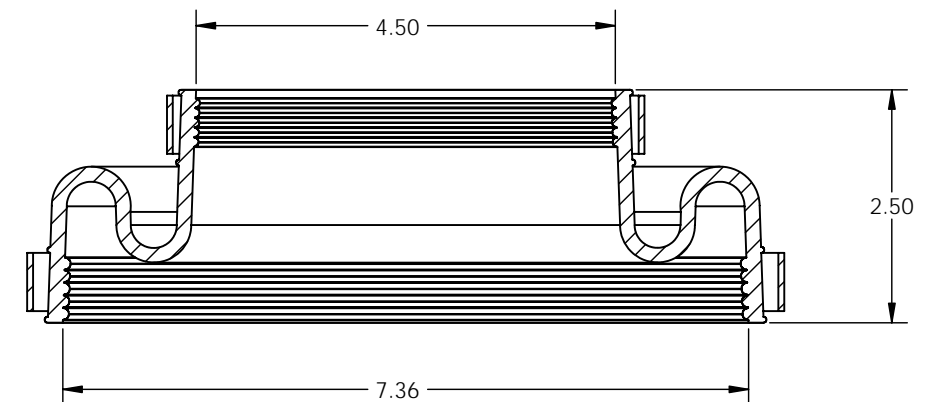
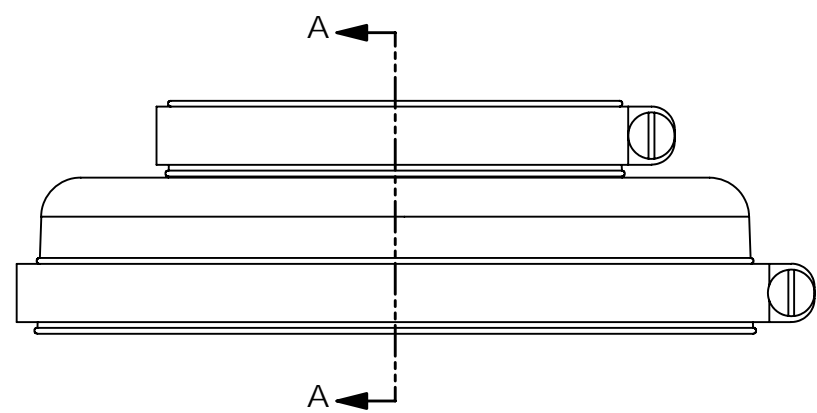
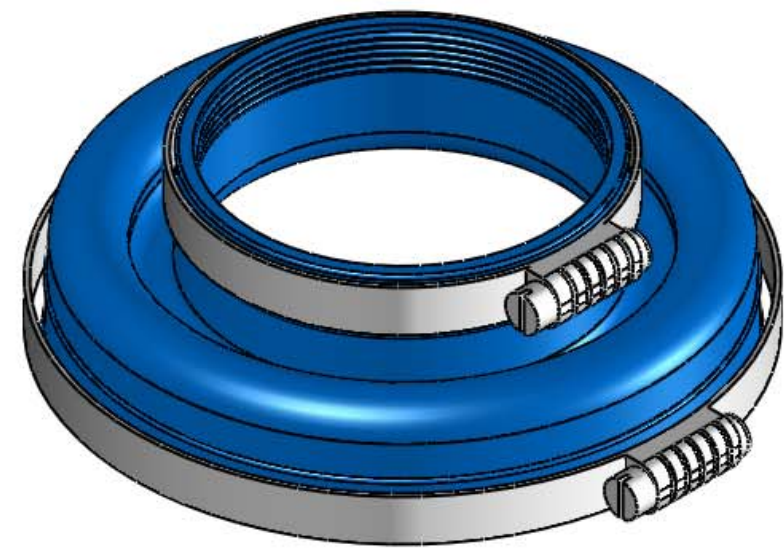
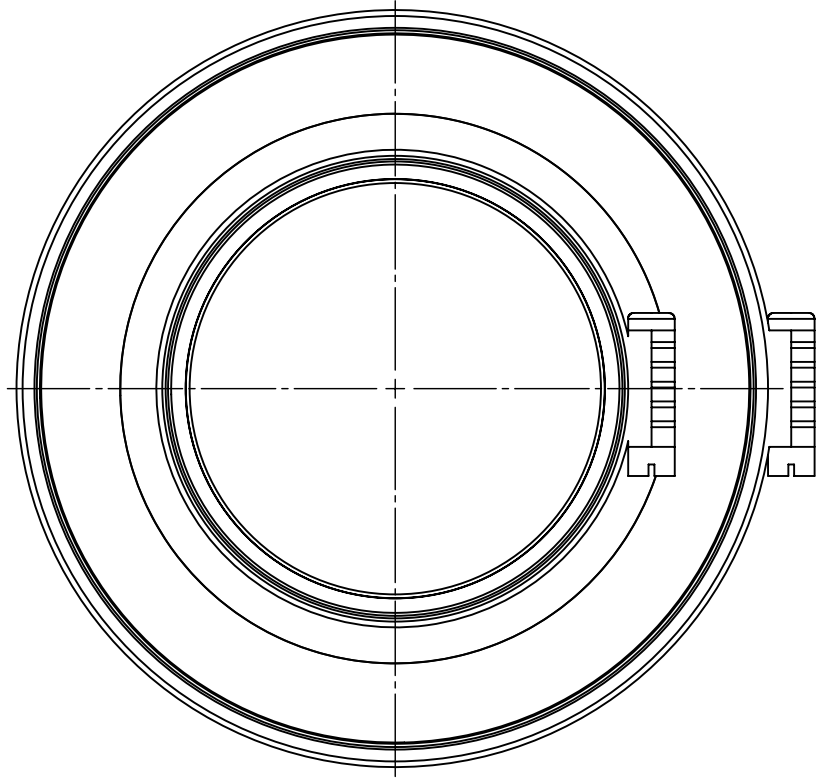

SECTION A-A

PROPRIETARY AND CONFIDENTIAL
 THE INFORMATION CONTAINED IN THIS
 DRAWING IS THE SOLE PROPERTY OF
BLUELINE TECHNOLOGIES LLC. ANY
 REPRODUCTION IN PART OR AS A WHOLE
 WITHOUT THE WRITTEN PERMISSION OF
BLUELINE TECHNOLOGIES LLC IS PROHIBITED.

UNLESS OTHERWISE SPECIFIED:	NAME	DATE
DIMENSIONS ARE IN INCHES	DRAWN	DH 12/1/04
TOLERANCES:	CHECKED	
FRACTIONAL ±	ENG APPR.	
ANGULAR: MACH ± BEND ±	MFG APPR.	
TWO PLACE DECIMAL ±	Q.A.	
THREE PLACE DECIMAL ±	COMMENTS:	
MATERIAL		
FINISH		
DO NOT SCALE DRAWING		



TITLE:		
PER 7.5x4.5		
SIZE	DWG. NO.	REV
C	PER 7.5x4.5	
SCALE: 0.75:1	WEIGHT:	SHEET 1 OF 1